



**ULTRA QUIET & OIL FREE
SMART AIR COMPRESSOR
OWNER'S MANUAL**

**CALIFORNIA
AIR TOOLS
20040SM**

4.0 HP 220V 60HZ 1-PHASE

12.80 CFM @ 40 PSI -- 10.6 CFM @ 90 PSI

20.0 GALLON STEEL TANK

SMART CONTROLLER



TABLE OF CONTENTS

INTRODUCTION	2
IMPORTANT SAFETY INSTRUCTIONS	3
LOCATIONS OF IMPORTANT LABELS	6
AIR COMPRESSOR COMPONENTS	7
PRE-OPERATION CHECKLIST	9
Package Contents & Assembly	9
Inspect for Damage	10
Save Packaging	10
Compressor Location	10
Electrical Power	11
OPERATING THE AIR COMPRESSOR	11
Introduction	11
Assembly	11
Test Run	12
Daily Operation	13
MAINTENANCE	15
Draining the Air Tank	15
Changing the Air Filter	15
Testing for Leaks	15
SMART Controller Features	15
Cleaning	15
STORAGE	16
TROUBLESHOOTING	17
SPECIFICATIONS	18
Electrical Circuit	18
Air Passage Drawing	18
WARRANTY	19

INTRODUCTION

WARNING

This manual contains important instructions for operating this product. For your safety, and the safety of others, be sure to read this manual thoroughly before operating the product.

Failure to properly follow all the instructions and precautions can cause you and others to be seriously hurt or killed.

Thank you for purchasing a California Air Tools, Inc. Air Compressor.

Please contact us if you have any questions.

Record the model and serial numbers indicated on your air compressor's nameplate:

Model No. _____

Serial No. _____

Date of Purchase: _____

Store/Dealer: _____

How to find a local service center:

Even quality built equipment might need service or repair parts. Contact the California Air Tools Customer Service Department:

Phone: 1-866-409-4581

Online: WWW.CALIFORNIAAIRTOOLS.COM

Please provide the information below:

Model number and Serial number and specifications shown on the Model number/Serial number plate.

Part number or numbers shown in the parts list section of the owner's manual for your air compressor model.

A brief description of the trouble with the air compressor.

Do not return your air compressor for service or parts to the store/dealer where purchased.

IMPORTANT SAFETY INSTRUCTIONS

Safety Messages & Signal Words:

⚠ DANGER

Indicates an immediate hazardous situation which, if not avoided, will result in death or serious injury to the operator or to bystanders.

⚠ WARNING

Indicates a potentially hazardous situation which, if not avoided, could result in death or serious injury to the operator or to bystanders.

⚠ CAUTION

Indicates a potentially hazardous situation which, if not avoided, may result in moderate or minor injury to the operator or to bystanders.

NOTICE

Indicates a situation which, if not avoided, may result in damage to product components or other property.

⚠ DANGER



RISK OF CUTTING

Moving parts can cause severe trauma.

Keep hands and feet away from rotating parts, tie up long hair, remove jewelry, and DO NOT wear loose clothing.

⚠ DANGER



SHOCK

There is a danger of electric shock.

Use only undamaged electrical cords.

DO NOT touch bare wires or receptacles.

DO NOT operate air compressor in wet weather or in wet conditions.

DO NOT touch air compressor or cords if hands or feet are wet.

Ensure that all cords are free of damage before connecting to the power supply.

Ensure that you have a sufficient electrical supply for supporting the requirements of the motor.

Improper installation of the grounding plug is able to result in a risk of electric shock. When repair or replacement of the cord or plug is required, do not connect the grounding wire to either flat terminal. The wire with insulation having an outer surface that is green with or without yellow stripes is the grounding wire.

This product must be grounded. In the event of an electrical short circuit, grounding reduces the risk of electrical shock by providing an escape wire for the electric current.

This product is equipped with a cord having a grounding wire with an appropriate grounding plug. The plug must be plugged into an outlet that is properly installed and grounded in accordance with the local codes and ordinances.

This product is for use on a nominal 220-V circuit and has a grounding plug similar to the plug illustrated in sketch A. Only connect the product to an outlet having the same configuration as the plug.

Do not use an adapter with this product.

⚠ WARNING



RISK TO BREATHING

Dust or dust-like particulates caused by power-sanding, sawing, grinding, drilling or any other construction-like activities can contain contaminants that are harmful to breathe.

Always use your air compressor in a well-ventilated and clean area.

Never breathe the air that comes directly out of the air compressor or air hose. This air is not suitable for breathing.

Always wear approved safety equipment. When performing dust-creating activities, securely wear properly-fit face masks or respirators.

If you feel ill from breathing while operating your air compressor, stop and seek medical attention immediately.

⚠ WARNING



FLYING OBJECTS

Flying object can cause injury to the eyes, head and other parts of the body.

Air-powered equipment and power tools are capable of propelling items (metal chips, fasteners and particulates) at high speed into the air and could result in injury.

Always wear approved head and eye protection.

Never point the air stream at any part of the body, or at another person or animal.

When operating the air compressor, make sure all other people and animals maintain a safe distance.

Do not move the air compressor when the air tank is under pressure.

Never use the air hoses to pull or move the air compressor.

Keep the air compressor on a flat surface.

⚠ WARNING



HOT SURFACE



FIRE

Air compressor surfaces become hot during operation.

DO NOT touch hot surfaces, because they can cause severe burns.

Do not touch the air compressor's cylinder head. During operation, the cooling fins of the cylinder head and delivery pipe become hot.

Allow the air compressor to cool before touching it.

DO NOT place a storage cover on the unit during operation. Only place a cover on the air compressor after it has thoroughly cooled down.

⚠ WARNING



EXPLOSION

Exercise caution when using pressurized air.

To prevent injury and for your general safety, only use high-pressure hoses, fittings and couplings designed for use with air compressors.

Inspect all hoses, fittings and couplings for leaks and wear. When leaks and wear detected, stop use and replace those items immediately. Do not repair.

Never leave pressurized air in the air tank when performing maintenance.

Never leave air compressor unattended with the power supply in use and the air hose connected.

NOTE: The compressor is designed for intermediate usage and should not be allowed to run continuously (i.e. where motor/pump continuously runs) for more than 60 minutes at a time. Intermediate ON/OFF usage during a standard workday is acceptable with an average 70/30 operating duty cycle.

⚠ WARNING



EXPLOSION

Improper care could lead to the air tank bursting or exploding.

Drain air tank daily or after each use to prevent moisture buildup in the air tank.

Rust can weaken the air tank and cause leaks or bursting. If rust is detected, replace tank immediately. Do not try to repair the air tank by welding, drilling or modifying it in any other way. These modifications can weaken the air tank and cause a hazardous condition.

If air tank develops a leak, replace the air tank immediately. Never repair, weld or make modifications to the air tank or its attachments.

Never make adjustments to the factory-set pressures.

Never exceed manufacturer's maximum-allowable pressure rating attachments.

Because of extreme heat, do not use plastic pipe or lead tin solder joints for a discharge line.

Power Requirements

- 220v 60hz 1-phase (215v – 250v range)
- 13-14 Amps (20 Amp breaker minimum suggested)
- Included NEMA 6-15P plug (6 foot power cable) may be connected to either a 6-15R or 6-20R electrical receptacle.

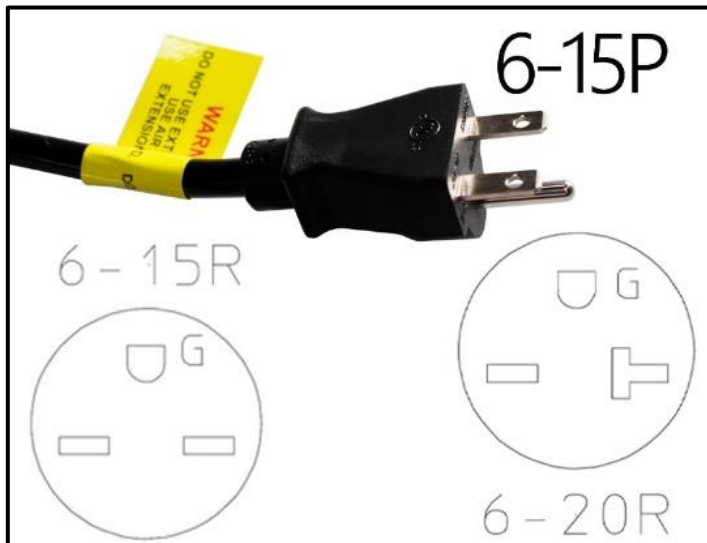

⚠ WARNING



EXPLOSION



FIRE

Use caution to minimize risk of fire or explosion.

It is normal for the air compressor motor and pressure switch to produce sparks while operating. If sparks come in contact with vapors from gasoline or solvents, they may ignite and cause a fire or explosion.

Abrasive tools such as grinders, drills and other tools are capable of making sparks that can ignite flammable materials.

Always operate the air compressor a safe distance away from flammable items. Use in well-ventilated areas.

Never exceed the maximum rated pressure.

⚠ CAUTION

Use caution when using extension cords.

Use an extension cord which is no more than 25' (7.6 m) long and at least 14 gauge.

Using an excessively long or thin-wired extension cord will cause severe damage to the motor.

Use only a 3-wire extension cord that has a 3-blade grounding plug.

As undersized cord results in a drop in the line voltage and loss of power and overheating.

When in doubt, use a heavier gauge. The smaller the gauge the more current the cord can carry.

⚠ CAUTION

THIS EQUIPMENT INCORPORATES PARTS, SUCH AS SNAP SWITCHES, RECEPTACLES AND THE LIKE THAT TEND TO PRODUCE ARCS OR SPARKS, THERE, WHEN LOCATED IN A GARAGE, IT SHOULD BE IN A ROOM OR ENCLOSURE PROVIDED FOR THE PURPOSE, OR SHOULD BE 18 IN (45.7 CM) OR MORE ABOVE THE FLOOR.

AIR COMPRESSOR

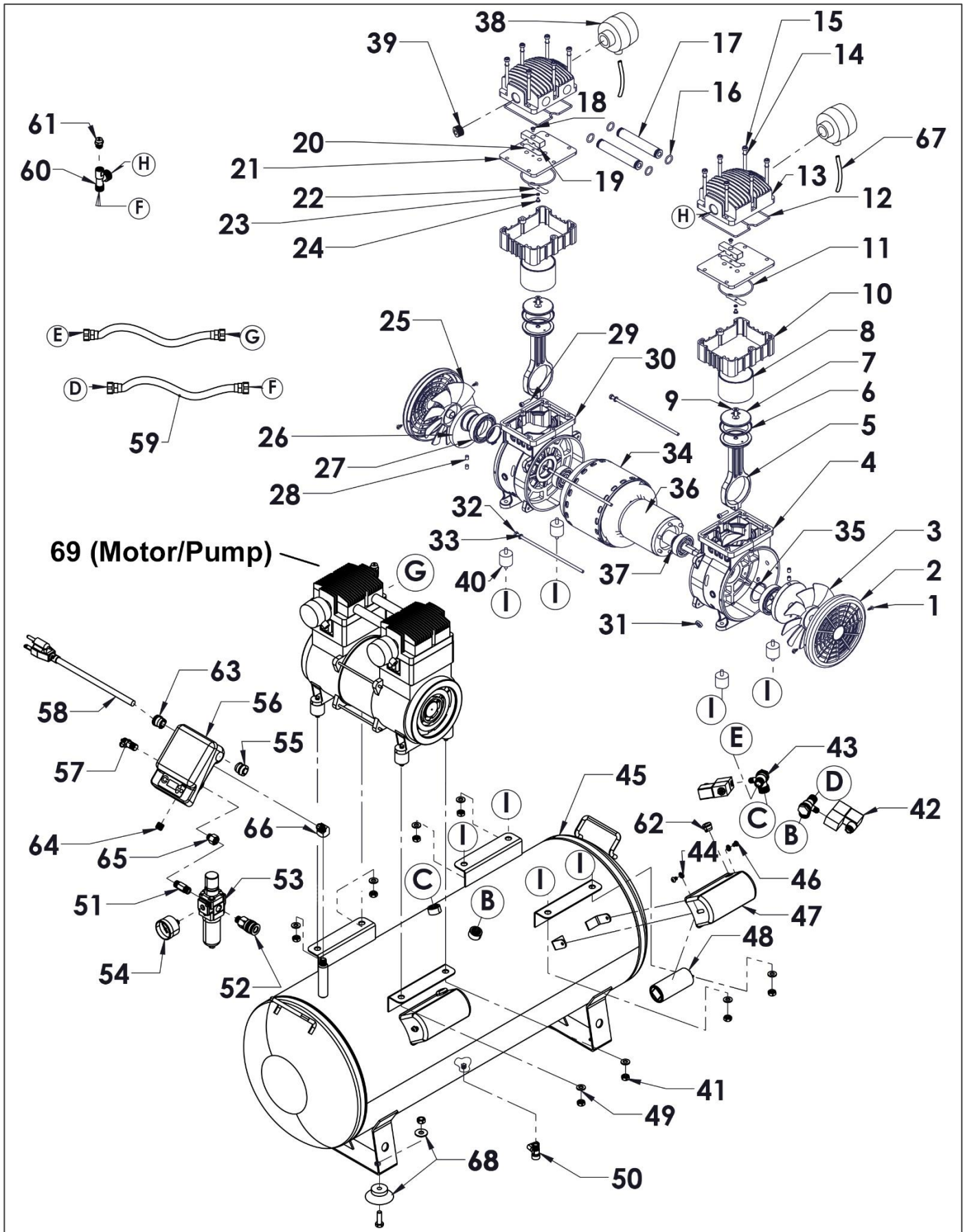

AIR COMPRESSOR

SPECIFICATION OF EXPLODED							
No.	DESCRIPTION	QTY	ITEM	No.	DESCRIPTION	QTY	ITEM
1	Fan Screw	4 (x2)	MP2001	38	Air Filter	2 (x2)	90260
2	Fan Cover	2 (x2)	MP2002	39	2HP Motor Head Plug 1/2" NPT	1 (x2)	282021
3	Left Fan	1 (x2)	MP2003	40	Shock Strut	4 (x2)	284551
4	Left Crank Case	1 (x2)	MP2005	41	Nut M8-125 Nylon	8	283691
5	Connect Rod	2 (x2)	MP2008	42	Unloader Valve	2	90840
6	Piston Ring	2 (x2)	MP2009	43	2 HP Check Valve	2	97502
7	Pressure Plate	2 (x2)	MP2010	44	Lock Washer M6	4	281191
8	Cylinder	2 (x2)	MP2012	45	Tank 20 Gal.	1	20040C-T/C
9	Pressure Plate Screw	2 (x2)	MP2011	46	Capacitor Cap Screw	4	283321-GA
10	Adjustment Stent	2 (x2)	MP2006	47	Capacitor Cap	2	283413-PI
11	Cylinder Obturating Ring	2 (x2)	MP2013	48	Capacitor	2	90237
12	Cylinder Head Obturating Ring	2 (x2)	MP2014	49	M8 Flat Washer	8	282311
13	Cylinder Head	2 (x2)	MP2015	50	Drain Valve	1	90392
14	Spring Washer	12 (x2)	MP2017	51	Connecting Bar MX	1	280943-GA
15	Cylinder Head Screw	12 (x2)	MP2016	52	Quick Connector 1/4" F	1	90394
16	Connecting Hose Obturating Ring	4 (x2)	MP2028	53	Filter Regulator	1	90546
17	Connecting Hose	2 (x2)	MP2029	54	Filter Pressure Gauge	1	96005
18	Screw	2 (x2)	MP2020	55	Strain Relief 8N-2	1	91292
19	Limited Block	2 (x2)	MP2021	56	Smart Controller	1	91477
20	Gassing Valve Plate	2 (x2)	MP2022	57	Safety Valve	1	90392
21	Valve Plate	2 (x2)	MP2023	58	Power Cord Black 220/60	1	90776
22	Air Inflow Valve Plate	2 (x2)	MP2024	59	Fluid Hose 3/8" x 14.5"	2	90501
23	Metal Strengthen Sheet	2 (x2)	MP2025	60	Easy Start Valve Elbow	2	90405
24	Screw	2 (x2)	90485	61	Easy Start Valve	2	90404
25	Right Fan	1 (x2)	MP2026	62	Strain Relief 6N3-4	1	283841
26	Crank	2 (x2)	MP2031	63	Strain Relief 7K-2	1	281751
27	Bearing 6008-2Z	2 (x2)	MP2028	64	1/4" NPT Opressor Allen	1	283181
28	Cheese Head Screw	4 (x2)	MP2029	65	1/4" FxM NPT Adapter	1	91392
29	Connecting Rod Screw	2 (x2)	90497	66	1/4" MXF NPT 45° Elbow	1	91500
30	Right Crank Case	1 (x2)	MP2005-R	67	Air Filter Tube	2	90661
31	Leading-Out Line Guard Circle	1 (x2)	MP2032	68	Cushion Foot for 20040	4	90352
32	Bolt	4 (x2)	MP2032	69	2 HP Motor/Pump (220v 60hz)	2	SP-9421-22060
33	Washer	4 (x2)	MP2034				
34	Stator	1 (x2)	MP2035				
35	Clip	1 (x2)	90490				
36	Rotor	2 (x2)	MP2036				
37	Bearing 6204-2Z	1 (x2)	MP2037				

PRE-OPERATION CHECKLIST

Package Contents & Assembly

Model: 20040SM

Package contents:

- Air Compressor
- 20040SM Owner's Manual
- MDR2i Smart Controller Owner's Manual
- Air Filters (4)
- Air Filter Intake Tubes (4), 8mm OD

Assembly:

Install the 4 Air Filters and 4 Air Intake Tubes

**Air Filters (4) &
Air Filter Tubes (4)**



1. Attach the air filters to the top rear sides of BOTH motor head's threaded $\frac{1}{2}$ " ports.
2. Screw the air filters clockwise until secure (hand tighten only).
Push (press fit) the 4" air filter intake tube into the air filter port/hole (8mm OD). Repeat for the other intake tube.
Note: orientation of the intake tubes does not matter, they may point any direction.

**Air Filters (4)
& Air Filters Tube (4)**

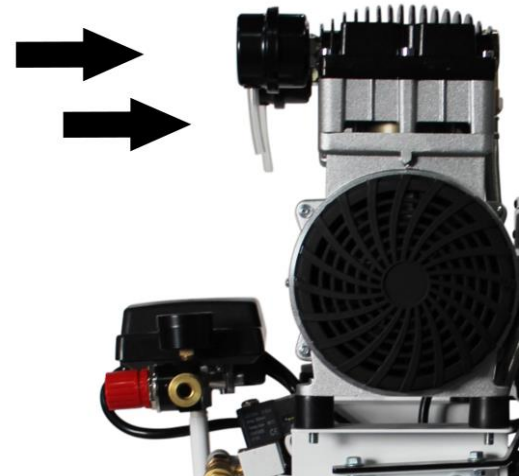

Inspect for Damage

Before using the air compressor, make sure the air tank is not damaged, inspect all parts for damage, and check that all pipes are firmly connected.

Do not use the air compressor if any damage is found. If damaged, have an authorized service center inspect and test the air compressor to ensure that it is working properly.

Save Packaging

IMPORTANT: Save all outside packaging in case you ever need to return the product for service or repair.

Compressor Location

Use on Flat Surface

For proper operation, the air compressor must be placed on a flat surface with an incline no greater than 15 degrees. It is suggested to secure the air compressor, by bolting down or earthquake strapping, to prevent model from accidentally falling over.

Maintain a Clear Area

It is very important that the air compressor is positioned so that there is adequate airflow around the machine. There must be at least 2 feet of obstacle-free space surrounding and above the air compressor.

!WARNING



RISK TO BREATHING

Dust or dust-like particulates caused by power-sanding, sawing, grinding, drilling or any other construction-like activities can contain contaminants that are harmful to breathe.

Always use your air compressor in a well-ventilated and clean area.

Never breathe the air that comes directly out of the air compressor or air hose. This air is not suitable for breathing.

Always wear approved safety equipment. When performing dust-creating activities, securely wear properly-fit face masks or respirators.

If you feel ill from breathing while operating your air compressor, stop and seek medical attention immediately.

!WARNING



EXPLOSION



FIRE

Use caution to minimize risk of fire or explosion.

It is normal for the air compressor motor and pressure switch to produce sparks while operating. If sparks come in contact with vapors from gasoline or solvents, they may ignite and cause a fire or explosion.

Abrasive tools such as grinders, drills and other tools are capable of making sparks that can ignite flammable materials.

Always operate the air compressor a safe distance away from flammable items. Use in well-ventilated areas.

Never exceed the maximum rated pressure.

Use in Areas with Clean Air

For proper operation and to maximize the longevity of the air compressor, it is very important that the air drawn into the air compressor is clean. The air compressor should not be used in areas where dust or particulates are in the air. This will damage the motor and impair proper operation.

IMPORTANT: Always use the air filter, properly installed.

Electrical Power

Electrical Power Requirements

Before using the air compressor, refer to the serial label for voltage and amperage requirements. Ensure there is a sufficient electrical supply for supporting the motor's requirements.

Use a dedicated 20 Amp Circuit or a 8000 Watt (running) Generator. Compressor requires 13-14 Amps for startup.

Low voltage and/or an overload circuit can cause the motor's overload protection system circuit breaker to trip.

⚠ DANGER

SHOCK

There is a danger of electric shock.

Use only undamaged electrical cords.

DO NOT touch bare wires or receptacles.

DO NOT operate air compressor in wet weather or in wet conditions.

DO NOT touch air compressor or cords if hands or feet are wet.

Ensure that all cords are free of damage before connecting to the power supply.

Ensure that you have a sufficient electrical supply for supporting the requirements of the motor.

Improper installation of the grounding plug is able to result in a risk of electric shock. When repair or replacement of the cord or plug is required, do not connect the grounding wire to either flat terminal. The wire with insulation having an outer surface that is green with or without yellow stripes is the grounding wire.

This product must be grounded. In the event of an electrical short circuit, grounding reduces the risk of electrical shock by providing an escape wire for the electric current.

This product is equipped with a cord having a grounding wire with an appropriate grounding plug. The plug must be plugged into an outlet that is properly installed and grounded in accordance with the local codes and ordinances.

Use a dedicated 20 (or 25/30) Amp Circuit:

220 Volts 60 Hertz 1-Phase (acceptable operating range 215 volts to 240 volts).

Electrical Extension Cords

⚠ CAUTION

Use caution when using extension cords.

Use an extension cord which is no more than 25' (7.6 m) long and at least 14 gauge.

Using an excessively long or thin-wired extension cord will cause severe damage to the motor.

Use only a 3-wire extension cord that has a 3-blade grounding plug.

As undersized cord results in a drop in the line voltage and loss of power and overheating.

When in doubt, use a heavier gauge. The smaller the gauge the more current the cord can carry.

Inspect all electrical extension cords to ensure that they are free of damage. When using an extension cord, use a heavy-duty cord that is no more than 25 feet long and at least 14 gauge. Use only a 3-wire extension cord that has a 3-blade grounding plug.

OPERATING THE AIR COMPRESSOR

⚠ WARNING

This manual contains important instructions for operating this product. For your safety, and the safety of others, be sure to read this manual thoroughly before operating the product.

Failure to properly follow all the instructions and precautions can cause you and others to be seriously hurt or killed.

Save this manual for future reference.

Introduction

This air compressor features a compact structure, stable performance, a high airflow rate, easy operation and maintenance. Because the air compressor produces no oil in the airflow, it can be used as an independent air supply machine for situations in which oil in the airflow is an issue. The motor directly drives the pistons and is able to function without lubrication for a long period of time.

Assembly

1. Connect an air supply hose [not supplied; featuring an **Industrial Male** (1/4" NPT) adapter/couple (pictured below)], to the Industrial Female (1/4" NPT) push-to-connect quick coupler on air compressor. Also see page 12..



2. Ensure that the power supply you are going to use is operating normally. **220 Volts 60 Hertz 20 Amp Outlet**.
3. Insert the power supply cord into the power supply socket.

Test Run

Before using the air compressor for the first time, complete a test run as follows:

1. Plug the power supply cord into a 220 volt 60hz 1-phase power supply socket (215v – 250v range).
2. Attach an air hose gun or pneumatic tool (i.e. [CAT-376 item](#); not supplied) to the 1/4" Industrial Female Push-To-Connect air port.

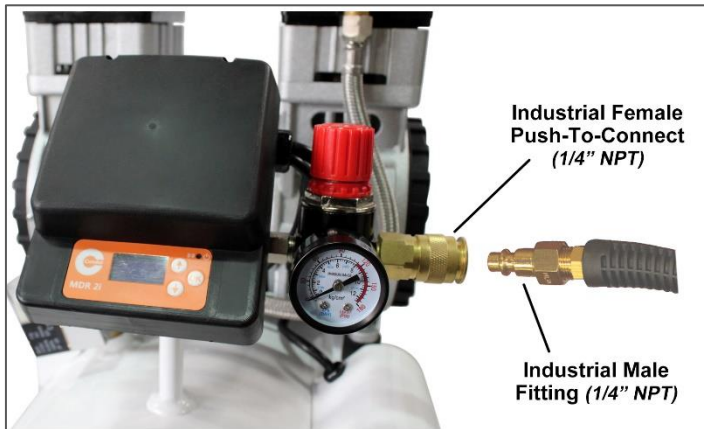

3. Ensure the Manual Ball Drain Valve, at bottom of tank, is closed prior to turning the air compressor on (i.e. turned 90 degrees)

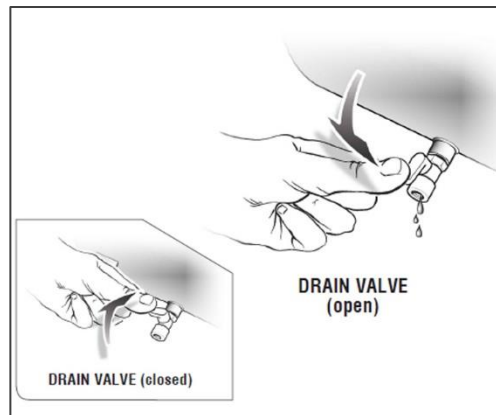
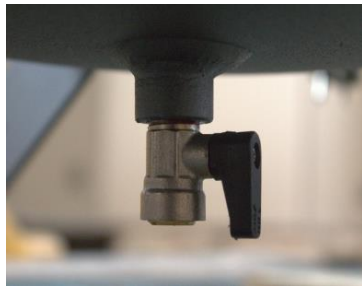

4. PRESS & HOLD the SMART switch OK button for 4 seconds to turn ON air compressor.

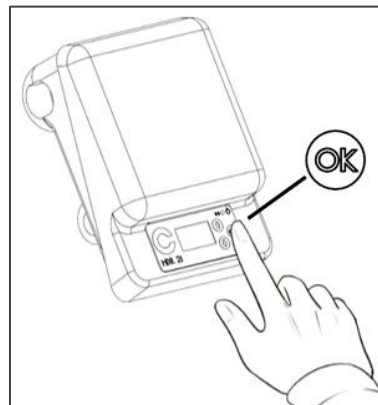

⚠ WARNING



FLYING OBJECTS

Flying object can cause injury to the eyes, head and other parts of the body.

Air-powered equipment and power tools are capable of propelling items (metal chips, fasteners and particulates) at high speed into the air and could result in injury.

Always wear approved head and eye protection.

Never point the air stream at any part of the body, or at another person or animal.

When operating the air compressor, make sure all other people and animals maintain a safe distance.

Do not move the air compressor when the air tank is under pressure.

Never use the air hoses to pull or move the air compressor.

Keep the air compressor on a flat surface.

5. Both Motor/pumps should start.

Pressure will slowly rise as pressure increases inside the air tank. When the pressure reaches **120 PSI (+/- 5 PSI)**, the Smart pressure switch will automatically turn the motor/pumps power off. This indicates the compressor is working normally.

NOTE: Working Pressure 90-120 PSI (+/-5 PSI). Adjustable up to 105 PSI Kick-On; 130 PSI Kick-Off maximum. Refer to Smart Controller Manual to adjust.

Unplug the power supply cord and release the air in the air tank by either of the following methods:

- Pull Safety Relief Valve ring to release air from tank. Suggested for initial testing or emergencies only.

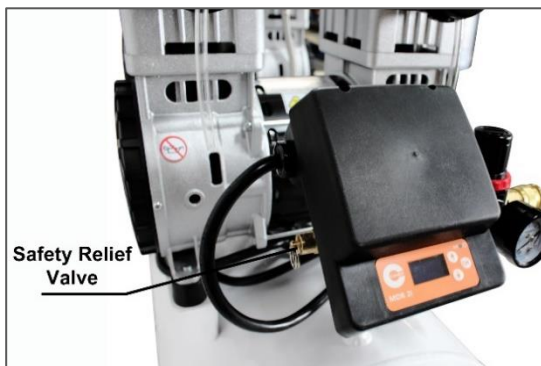

- Expel air from compressor using connected Air Hose Gun/Tool (i.e. [CAT-376 item](#); not supplied). This is the recommended discharge method for all regular & daily air compressor operations.

Note: If there is an air leak from the compressor the pressure in the air tank decreases, the Smart Controller (pressure switch) resets and the motor automatically turns back on.



If compressor fails to start or you detect an air leakage, deactivate the air compressor and release the air from the tank (if under pressure) – see Step 3 above. Unplug the power supply cord and contact Customer Support for Assistance.

DAILY OPERATION

Starting the compressor:

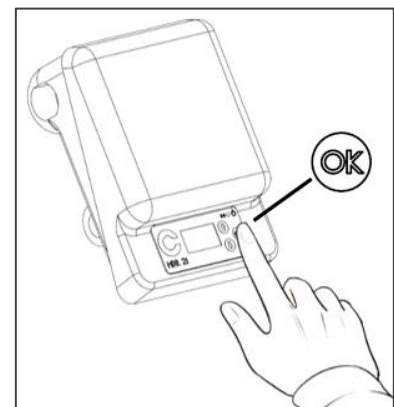
- PRESS & HOLD the SMART switch **OK** button for 4 seconds to turn OFF air compressor.
- Attach an air hose gun or tool (i.e. [CAT-376 item](#); not supplied) to the 1/4" Industrial Female Push-To-Connect Air Port.



⚠ WARNING	
	
HOT SURFACE	FIRE
<p>Air compressor surfaces become hot during operation.</p> <p>DO NOT touch hot surfaces, because they can cause severe burns.</p> <p>Do not touch the air compressor's cylinder head. During operation, the cooling fins of the cylinder head and delivery pipe become hot.</p> <p>Allow the air compressor to cool before touching it.</p> <p>DO NOT place a storage cover on the unit during operation. Only place a cover on the air compressor after it has thoroughly cooled down.</p>	

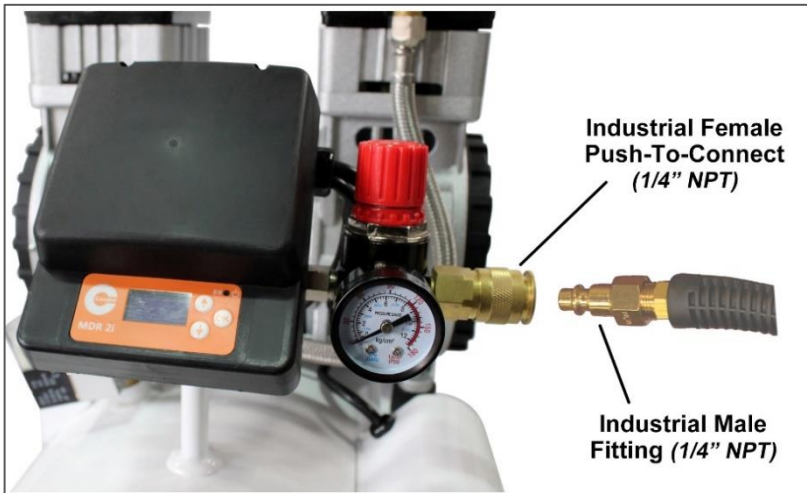

3. Close Manual Ball Drain valve and ensure both air filters are attached to motor/pump.
4. Plug the power supply cord into a power supply socket.
5. **PRESS & HOLD** the SMART switch **OK** button for 4 seconds to turn ON.

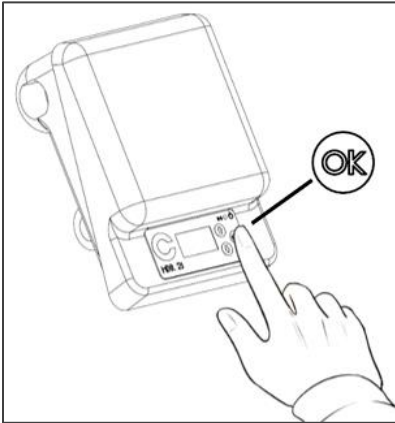

6. Allow the two (2) motors run and tank fill until motor/pumps stop and turn off.
7. To regulate the air flow.
While the air compressor is running, turn "On" your tool and turn the regulator knob to the right increasing the pressure.
Turn the pressure up until the desired pressure is reached.
9. Operate air tool normally.

NOTE: Working Pressure 90-120 PSI (+/-5 PSI).
Adjustable up to 105 PSI Kick-On; 130 PSI Kick-Off
maximum.

Shutting down the compressor:

1. **PRESS & HOLD** the SMART switch **OK** button for 4 seconds to turn compressor OFF.
2. Unplug the power supply cord.
3. Remove the pressure and water in the air tank through manual drain valve (or alternatively using connected air hose gun/kit or pneumatic tooling to release air pressure from tank).

MAINTENANCE

Remove Water from Tank Daily:

Turn the Manual Ball Drain Valve lever to be inline with tubing; water/air will eject from valve opening. Close lever (90 degree angle) when water is no longer draining/visible.

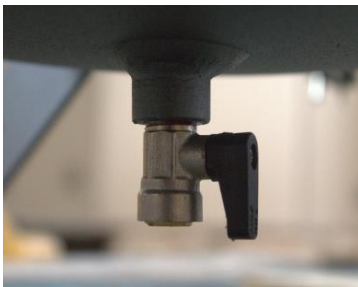
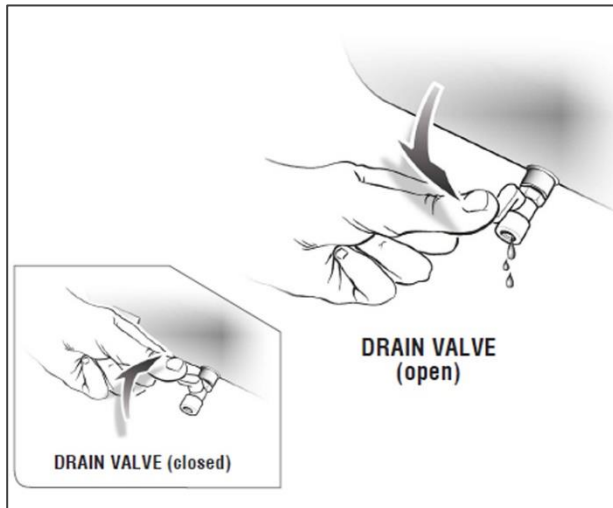

Cleaning or Changing the Air Filter

The air filter is designed to reduce noise and help prevent particulates in the air from entering and damaging the air compressor.

After being used for a period of time, the air filter will become clogged. This will reduce the air intake capabilities of the air compressor, reducing performance. Therefore, the air filter(s) must be cleaned or replaced regularly.

1. Open the lid on the air filter, then remove the air filter element.
2. To clean the element blow off or brush off the dirt and dust.
3. If clogged, replace with a new air filter.

Testing for Leaks

Make sure all connections are tight. Do not overtighten.

A small leak in any hose or pipe connection will reduce the air

compressor's performance.

To test for small leaks, spray a small amount of soapy water on the area suspected of leaking. If the soap bubbles, replace the broken part.

Cleaning

Clean items with a soft brush, or wipe with a moistened cloth using a biodegradable solvent.

Do not use flammable liquids such as gasoline or alcohol. Always keep parts clean from dirt and dust for better performance.

SMART Controller Features

MDR2i OLED Smart Pressure Switch for remote monitoring and control. Refer to **MDR 2i Smart Controller Manual**.



- **Programmable ON/OFF Times**
- **Pressure ON Level** (i.e. re-start pressure)
- **Pressure OFF Level** (i.e. shutdown pressure)
- **Unloader Relay Delay:** Delay time for activation of the unloader valves during compressor start-up (load reduction).
- **AutoDrain Time:** Select the time between each drain activation.
- **Drain Valve Time:** AutoDrain valve opening duration.
- **Overcurrent Limit:** (i.e. functions as an electrical trip/breaker).
- **Pressure Units:** Select [bar] or [PSI]
- **Total Active (Motor-Pump) Running Hours**

STORAGE

Before storing the air compressor for a prolonged period of time:

1. Turn off the power supply.
2. Disconnect the power cord from the power supply and wrap the power cord around the air compressor handle to reduce the risk of damage.
3. Pull the safety relief valve and release all the pressure from the air tank (*Note: the safety relief valve will normally open when tank pressure exceeds 140 PSI*)
4. Clean the air compressor to remove all dirt and dust.
5. Cover the air compressor with a cover to protect the unit from dust and moisture.
6. Do not stack or store any items on top of or around the air compressor. Damage could occur.

⚠ CAUTION

**TO REDUCE THE RISK OF ELECTRIC SHOCK,
DO NOT EXPOSE TO RAIN.**

STORE INDOORS.

TROUBLESHOOTING

PROBLEM	POSSIBLE CAUSE	POSSIBLE SOLUTIONS
Pressure drop in the tank.	Air leaks at connections.	Let the compressor build pressure in the tank, to the maximum pressure if possible. Brush soapy water on air connections and look carefully for air bubbles. Tighten leaky connections. If the problem persists, contact Customer Support for further assistance.
The unloader valve leaks when the compressor is idle.	Unloader valve seal is defective.	Let the air in the air tank flow out until all the pressure is released. Then remove the unloader valve plug and clean the valve seal. If necessary, replace the seal and then reinstall all components. Replace Unloader.
The compressor stopped and does not start.	The motor/pump thermal protector turned on because the motor is overheating.	Check that the main voltage corresponds to the air compressor specifications. An extension cord that is too thin or too long can cause a voltage drop and cause the motor to overheat. Excessive use (over 1 hour continuous use) can cause the motor(s) to overheat Allow the motors to cool down.
	Motor windings are burned out.	Contact Customer Support.
The motor does not start and makes a humming noise.	Head Pressure	Do a Check Valve Adjustment. Drain air tank.
	Low voltage supply to the motors. 220 volts 60hz 1-phase required. (acceptable range 215v – 250v)	Remove check valve cap Take out check valve spring Clean inside the check valve and and elongate.the spring. Replace spring and cap
The motor does not start or starts slowly.	Low voltage supply to the motor.	Check that the main voltage corresponds to the air compressor specifications. An extension cord that is too thin or too long can cause a voltage drop. Use heavy duty extension cords. Ensure that the air compressor is plugged into a fully functional power outlet
The compressor is noisy with metallic clangs.	Compressor motor/pump head gasket or reed valve is damaged	Stop the compressor and contact Customer Support. Service or replace motor/pump.
The compressor does not reach the maximum pressure.	Compressor head gasket or reed valve is faulty.	Stop the compressor and contact Customer Support. Service or replace motor/pump.
The compressor doesn't seem to provide as much air as it did when new and/or the compressor cuts off within a much shorter time period.	The pressure switch needs adjusting.	Stop the compressor and contact Customer Support.
	The tank is full of water due to condensation.	Open the drain valve and release the water from the tank. Clean Auto Drain-Manual Drain Strainer (filter).
The motor pump unit does not stop when the tank pressure reaches its maximum working pressure (120 PSI).(plus or minus 5 PSI)	SMART Controller (Pressure) Switch defective or needs adjusting.	Stop the compressor immediately and contact Customer Support.

SPECIFICATIONS

Electrical Circuit

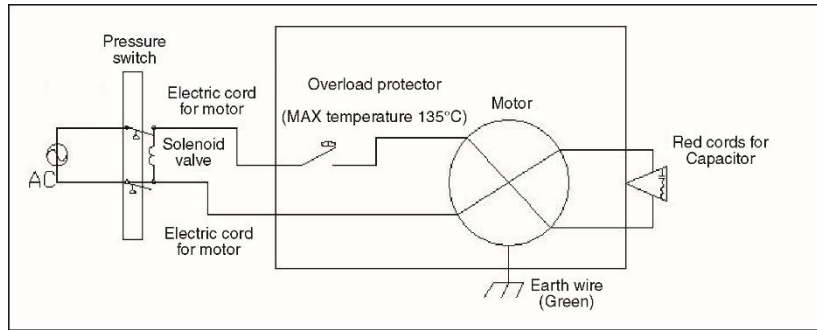

Air Passage Drawing

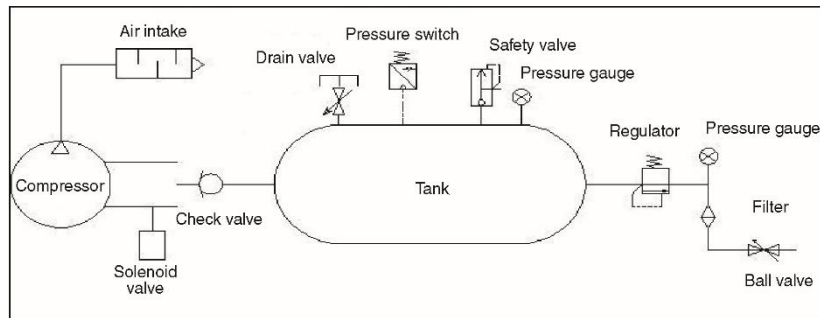

MDR2i Controller/Pressure Switch Wiring

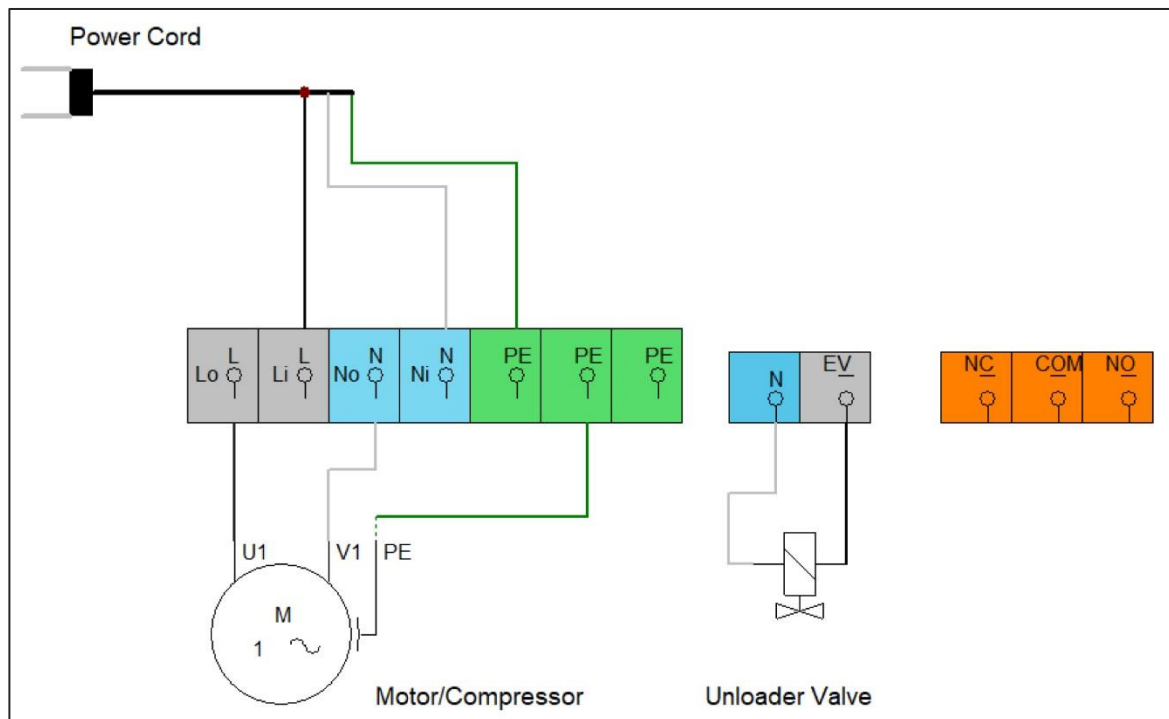

CALIFORNIA AIR TOOLS INC. LIMITED WARRANTY

This warranty is limited to Air Compressors distributed by:

California Air Tools, Inc.
8560 Siempre Viva Road
San Diego, CA 92154

Limited Warranty

California Air Tools Inc. will repair or replace, free of charge, to the original retail customer who purchased a California Air Tools, Inc. Air Compressor from an authorized dealer, distributor or distributor's dealer in North America.

This warranty does not transfer to subsequent owners.

California Air Tools Inc. will repair or replace, at its option, any parts of the portable air compressor that are proven by an authorized service center to be defective in material or workmanship under normal use during the applicable warranty time period as stated below. This limited warranty covers the cost of the replacement parts and labor for all defects when installed by an authorized service center. Transportation charges are the responsibility of the customer. Any part replaced under warranty becomes the property of California Air Tools Inc.

All parts replaced under warranty will be considered as part of original product, and any warranty on those parts will expire coincident with the original product warranty.

Limited Warranty Periods

Non-commercial / Non-rental (personal use by a retail customer): 1 year parts and labor
Commercial / Rental (usage for income, business use): 1 year parts and labor

The limited warranty period begins on the date of retail purchase by the original purchaser.

Disclaimers, Limitations of Remedies & Exclusions

This warranty gives you specific legal rights, and you may also have other rights which may vary from state to state.

Disclaimer of Other Warranties

To the fullest extent permitted by applicable law, this limited warranty is exclusive and expressly in lieu of any and all other warranties, including, without limitation, any implied warranties of merchantability or fitness for a particular purpose or any other implied warranties that may arise from the course of dealing or usage of the trade. California Air Tools Inc. hereby disclaims and excludes all other warranties. To the extent that California Air Tools Inc. products are consumer products under applicable federal and state law with respect to any customer, the duration of any implied warranties (including but not limited to implied warranties of merchantability or fitness for a particular purpose) are limited to the shortest duration permitted by applicable law or the Limited Warranty period provided herein, whichever is longer.

Limitations of Remedies

California Air Tools Inc. shall not be liable to customer, or anyone claiming under customer, for any other obligations or liabilities, including but not limited to, obligations or liabilities arising out of breach of contract or warranty, negligence or other tort or any theory of strict liability, with respect to the air compressor or California Air Tools Inc. acts or omissions or otherwise. To the fullest extent permitted by applicable law, California Air Tools Inc. shall not in any event be liable for incidental, compensatory, punitive, consequential, indirect, special or other damages, including but not limited to loss of use, loss of income, loss of time, loss of sales, injury to personal property, or liability customer incurs with respect to any other person, or any other type or form of consequential damage or economic loss.

Exclusions

In addition to the foregoing disclaimers, limitations and terms, this limited warranty shall not apply to and does not cover accessories, nor does it cover products that are in any way subject to any of the following:

1. Improper setup, installation or storage.
2. Lack of proper maintenance and service.
3. Accident, damage, abuse or misuse.
4. Abnormal operating conditions or applications.
5. Repair or modification by customer or any third party without written consent of California Air Tools Inc.
6. Use under operating conditions or in applications not recommended by California Air Tools Inc.
7. Normal wear.
8. The use of accessories or attachments not recommended by California Air Tools Inc.
9. Acts of God.

The application of these exclusions will be determined at the sole discretion of California Air Tools Inc.

Maintenance & Troubleshooting Guide

California Air Tools provides Maintenance & Troubleshooting Guide on our website WWW.CALIFORNIAAIRTOOLS.COM.

Valuable information regarding set-up, operation and maintenance.

Please visit our website and view these videos for beneficial information.

Service or Parts

Warranty is also available by keeping and showing your original receipt from the date of purchase to an Authorized California Air Tools Service Center.

For all customer service inquiries call **1-866-409-4581** or visit

WWW.CALIFORNIAAIRTOOLS.COM

Go to the “Contact Us” Tab

Click on “Service & Parts” Buttons for the Fastest Service.